

冰水入
3" FLANGE

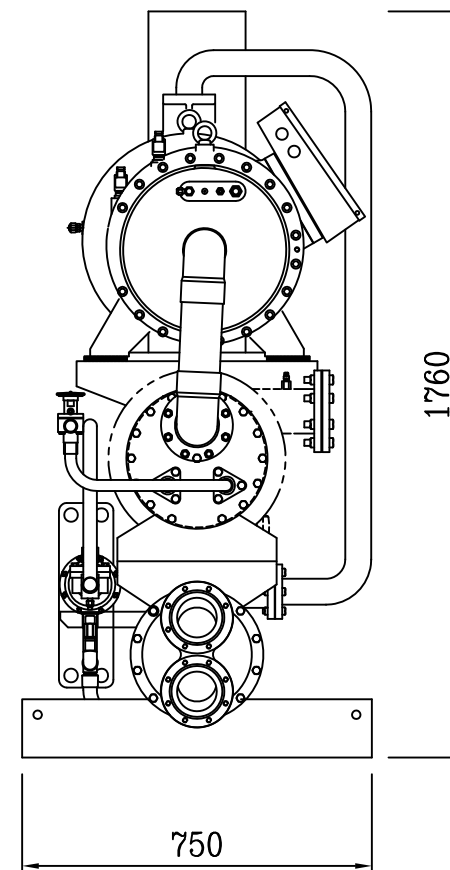

冰水出
3" FLANGE

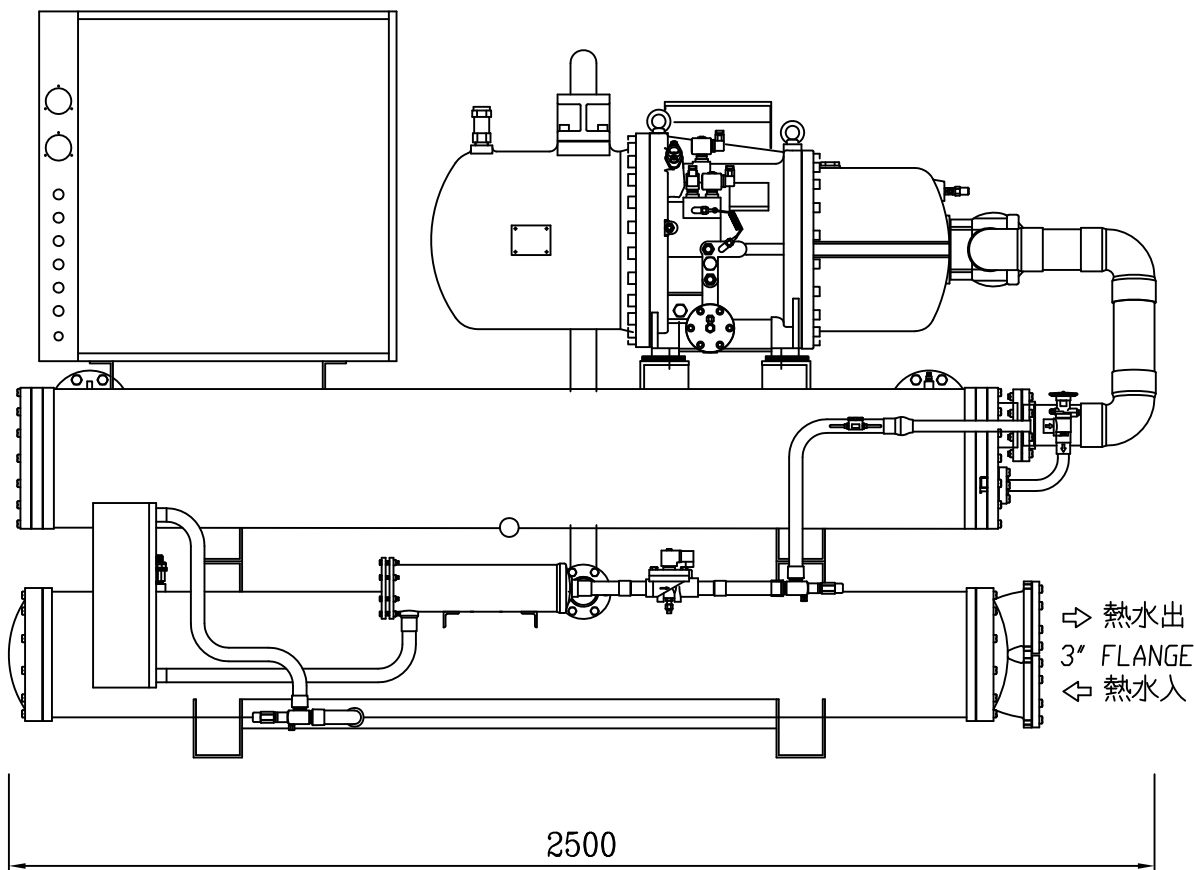

揚帆興業股份有限公司
YANGFAN DEVELOPMENT CO., LTD.

審定 APPR.	陳美玲	繪圖 DRAWN	張均柔	單位 UNIT	mm	專案號碼 PROJ.NO.		業主 OWNER	
設計 DESIGNED		日期 DATE	108.12	比例 SCALE	NS	圖號 DRG. NO.	YSHWR-045S	圖名 TITLE	水對水螺旋式熱泵熱水機(冷熱兩用)